

MANUAL DE MONTAJE

FP/B



MAMPARA FRONTAL DE DUCHA

1 HOJA FIJA + 1 ABATIBLE

FP/B

1

PRESENTAR "U" A PARED Y MARCAR
LOS TALADROS.



2

TALADRAR CON BROCA Ø 6 MM.

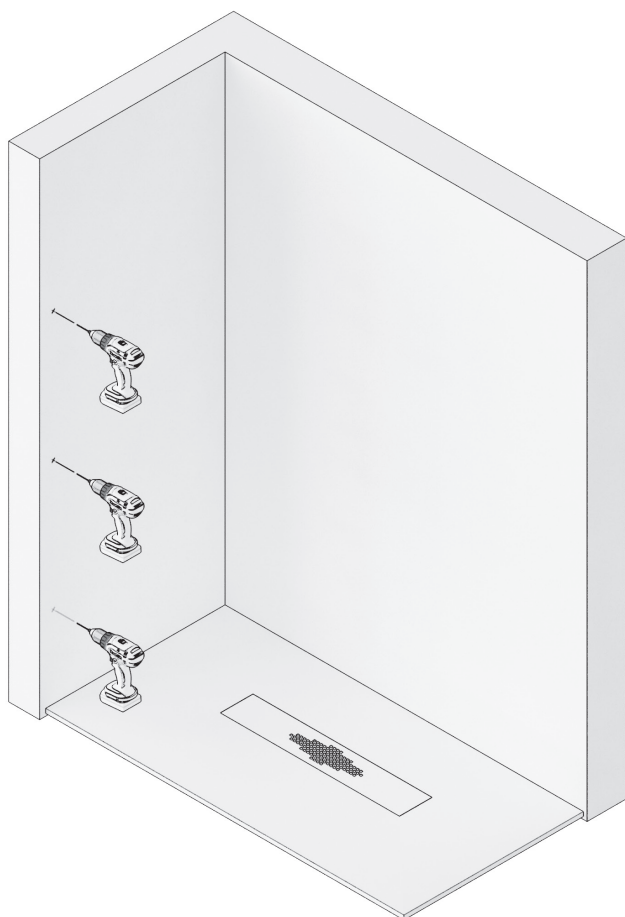

3

ATORNILLAR LA "U" A PARED USANDO TACOS DEL N°6 Y TORNILLOS 4,2 x 32



4

COLOCAR GOMA ESTANQUEIDAD INFERIOR FIJO E INTRODUCIR CRISTAL EN LA "U", APOYANDO SOBRE ESTA.

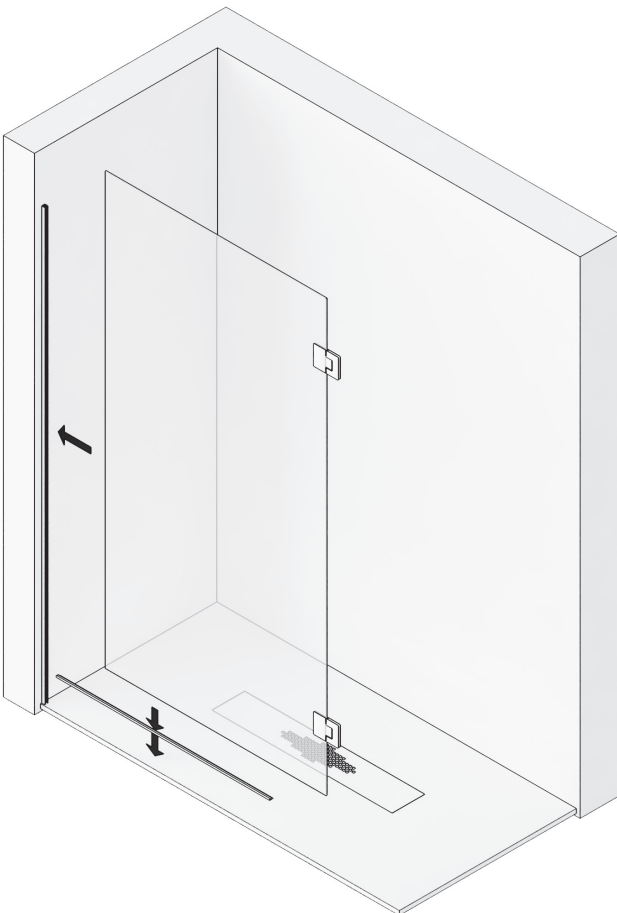

FP/B

5

NIVELAR Y ENGOMAR CRISTAL FIJO A LA "U" FIJO A PARED. COLOCAR LA GOMA BURBUJA CORTANDO LOS ENCAJES A LAS BISAGRAS.

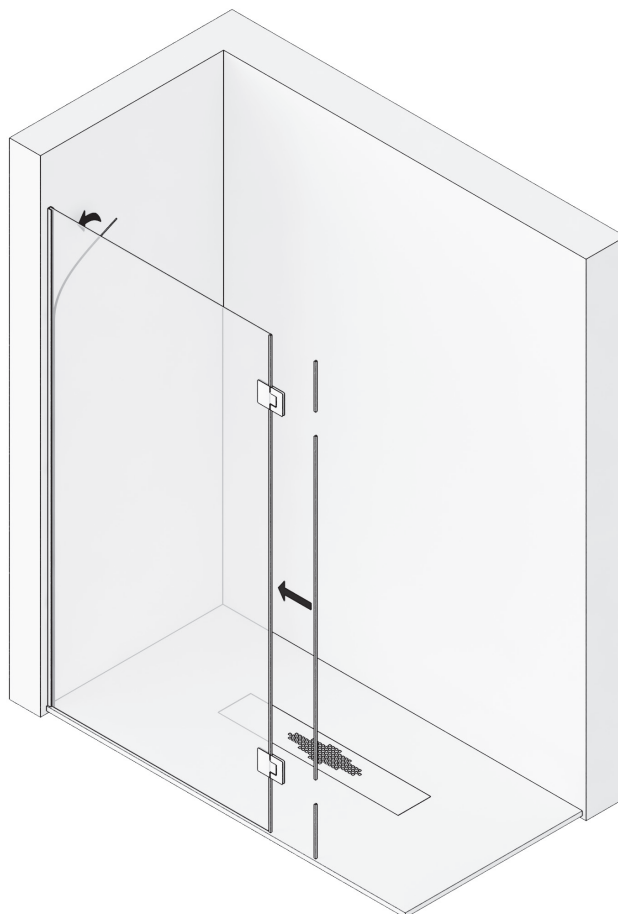
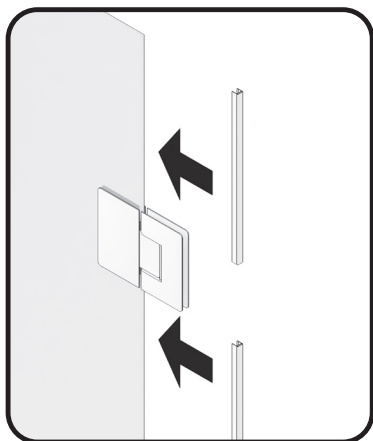

6

PRESENTAR BARRA ESTABILIZADORA DE PARED A VIDRIO CON NIVEL, AJUSTAR TUBO A SU DISTANCIA Y MARCAR TALADRO EN PARED.

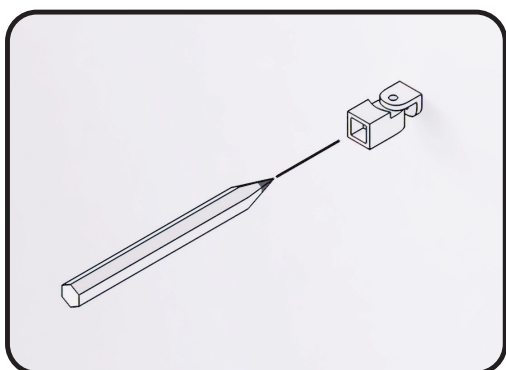

7

ATORNILLAR SOPORTE A PARED Y MONTAR LA BARRA ESTABILIZADORA FIJANDO LA PINZA AL CRISTAL.



8

PRESENTAMOS LA HOJA ABATIBLE SOBRE LAS BISAGRAS VIDRIO-VIDRIO DE LA HOJA FIJA SOPORTE PUERTA PRE-MONTADA

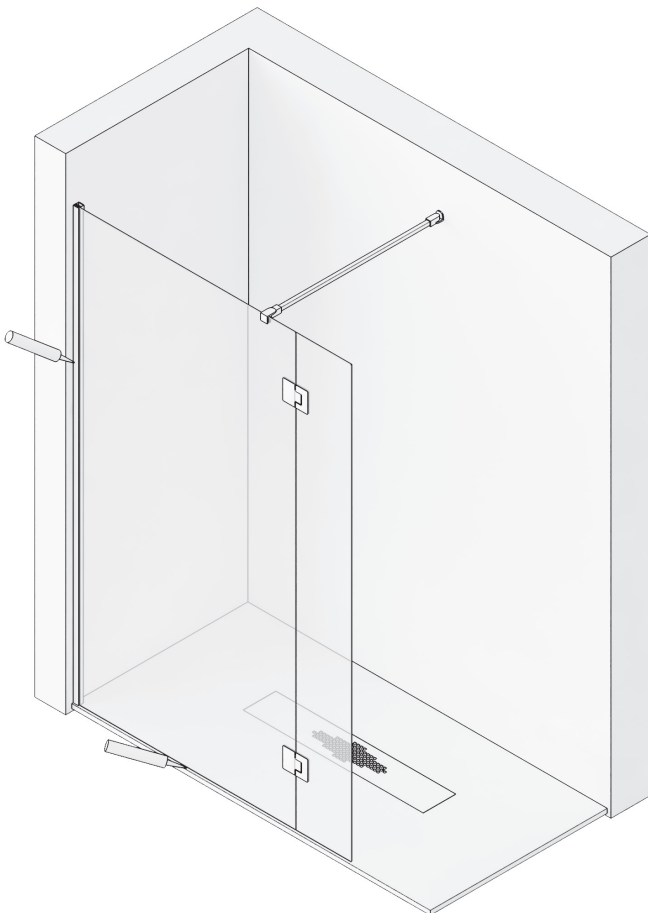

9

SELLAR CON SILICONA EL CONTORNO EXTERIOR DE LA MAMPARA.

FP/B

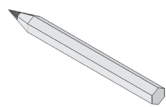

Ø 6 MM.

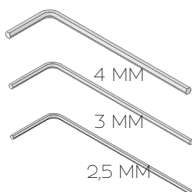
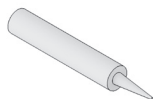
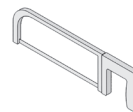
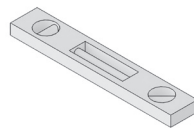

4 MM

3 MM

2,5 MM

1X



HOJA ABATIBLE

2X

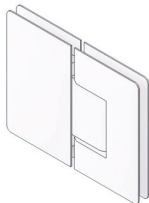

BISAGRAS VIDRIO-VIDRIO
DE ACERO INOX

1X



HOJA FIJA

1X



PERFIL "U" FIJO A PARED

1X



BARRA ESTABILIZADORA

1X



GOMA BURBUJA

1X

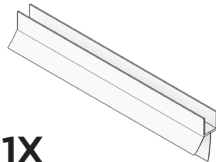

GOMA INFERIOR BARREDERA

1X

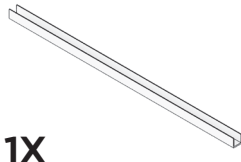

GOMA ESTANQUEIDAD FIJO

1X



GOMA FIJO "U" A PARED

4X



TACOS N°6

4X

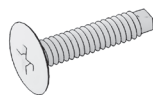

TORNILLO 4,2 X 32